

Linda

SITS



Linda

UPHOLSTERY



fabric

COMFORTS



standard



premium

COVERS



fixed



loose
with velcro

SPECIAL



modular
system

All elements available also as freestanding elements.

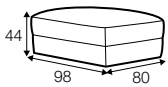

footstool 98x80

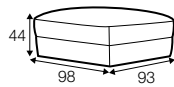

footstool 98x93

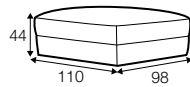

footstool 110x98

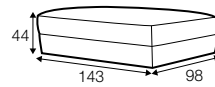

footstool 143x98

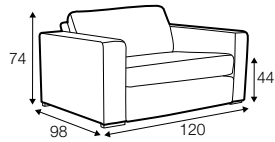

element 80

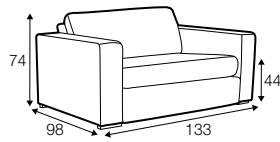

element 93

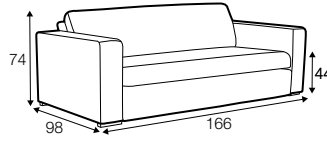

element 126

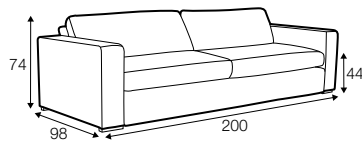

2,5 seater

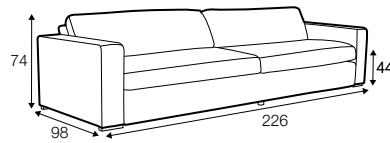

3 seater

modular system

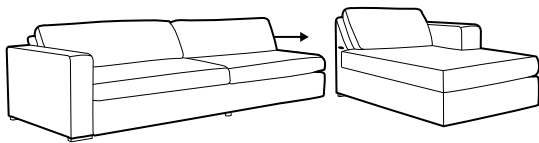

elements of the modular system

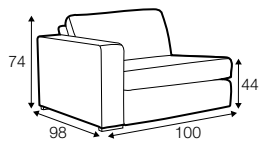

element 80 left / or right

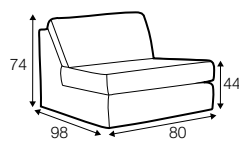

element 80 without armrests



element 93 left / or right

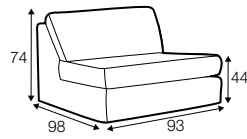

element 93 without armrests

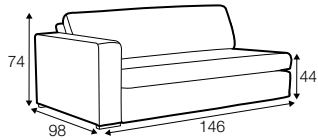

element 126 left / or right



element 126 without armrests

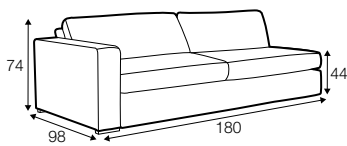

2,5 seater left / or right

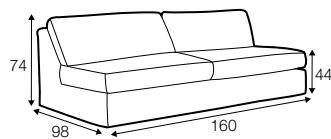

2,5 seater without armrests

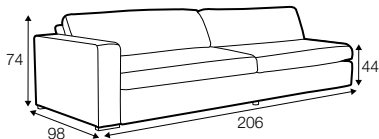

3 seater left / or right

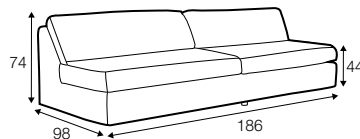

3 seater without armrests

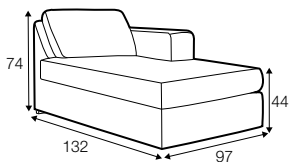

chaiselongue 80 right / or left

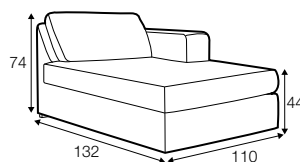

chaiselongue 93 right / or left

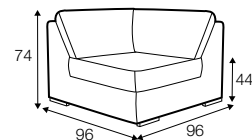

corner 90°

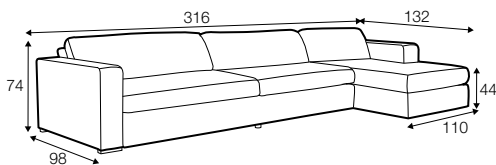

example

3 seater left / or right + chaiselongue 93 right / or left

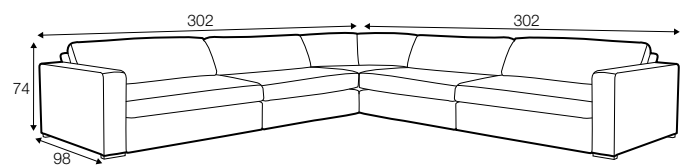

example

3 seater left + corner 90° + 3 seater right

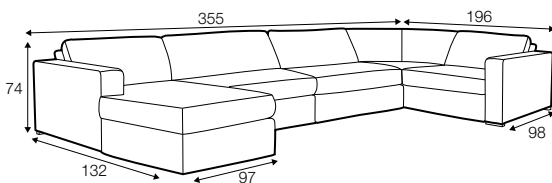

example

chaiselongue 80 left / or right + 2,5 seater without armrests + corner 90° + element 80 right / or left

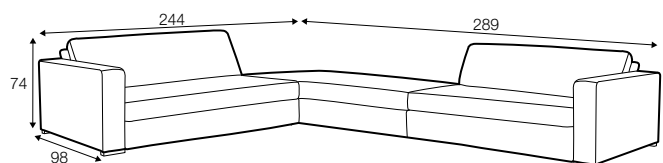

example

element 126 left + footstool 143x98 + element 126 right

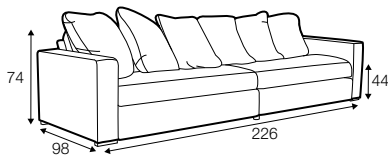

example with cushions

3 seater

4x cushion 55x55 + 2x cushion 60x60

extra dimensions

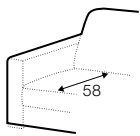

depth of seat

accessories

All elements available with square back cushions.



back cushion
40x40

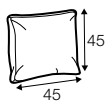

back cushion
45x45

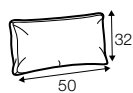

back cushion
50x32

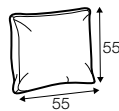

back cushion
55x55

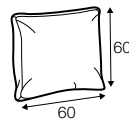

back cushion
60x60

legs

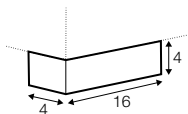

no. 132 + no. 37C
wood + plastic
under the armrest only

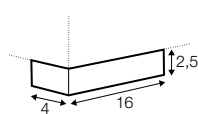
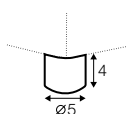

no. 132A + no. 37E
wood + plastic
under the armrest only

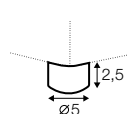

profile

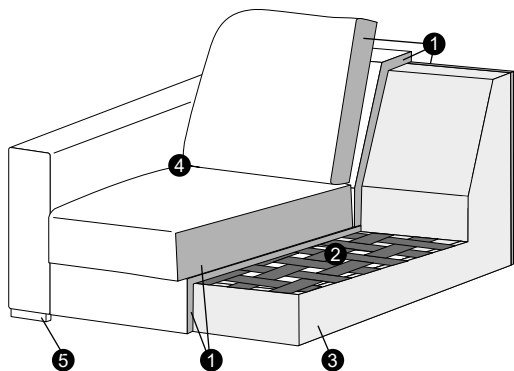

standard

1. polyurethane foam/ high resilient polyurethane foam
2. upholstery belts
3. FSC® certified solid wood and wood based elements
4. fabric
5. FSC® certified solid wood or plastic legs

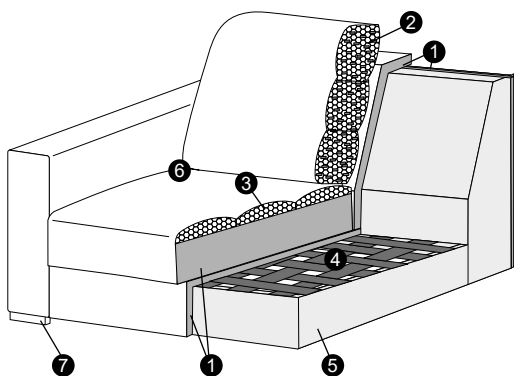

premium

1. polyurethane foam/ high resilient polyurethane foam
2. foam flakes with silicone balls
3. silicone balls
4. upholstery belts
5. FSC® certified solid wood and wood based elements
6. fabric
7. FSC® certified solid wood or plastic legs